



The dynamic efficiency is **0.96** for all ratios

Input speed (n_1) = 1400 min⁻¹

Output speed n_2 [min ⁻¹]	Ratio i	Motor power P_{1M} [kW]	Output torque M_{2M} [Nm]	Service factor f_s	Nominal power P_{1R} [kW]	Nominal torque M_{2R} [Nm]	B5 motor flanges		B14 motor flanges		Output shaft  Standard ø35	Ratio code 
							-D 80	-E 90	-U 100-112			
232	6.03	4	155	1.6	6.1	240					3011	01
151	9.26	4	238	1.1	4.5	270					308	02
123	11.36	4	291	1.2	4.7	350					2011	03
91	15.36	4	394	1.0	3.8	385					1611	04
80	17.46	4	448	0.9	3.5	400					208	05
70	19.97	3	386	1.1	3.1	410					1311	06
59	23.60	3	456	0.9	2.7	410					168	07
57	24.45	3	472	0.9	2.6	410					1111	08
45.6	30.69	2.2	436	0.9	2.0	410					138	09
39.6	35.35	1.5	346	1.2	1.8	410					811	10
37.3	37.57	1.5	368	1.1	1.7	410					118	11
28.8	48.68	1.1	348	1.0	1.1	365					611	12
25.8	54.33	1.1	389	1.1	1.2	410					88	13
18.7	74.81	0.75	367	1.0	0.73	360					68	14

Motor flanges available
Flange motore disponibili

 B) Supplied with reduction bushing
Fornito con Bussola di Riduzione

B) Available on request without reduction bushing
Disponibile a Richiesta senza Bussola di Riduzione

 C) Motor flange holes position
Posizione Fori Flangia Motore

Lubrication

Lubrificazione

Always specify the mounting position
Specificare sempre la posizione di montaggio

Unit X62L is supplied with synthetic oil to assure long life lubrication.
Food grade oil is available on request.

See Table 1 for lubrication and recommended quantity.



See Table 2 for possible radial and axial loads on the gearbox.

Il riduttore tipo X62L viene fornito con olio sintetico e lubrificazione tipo "long life".

Disponibile a richiesta olio alimentare.

Vedi Tabella 1 per oli e quantità consigliati.

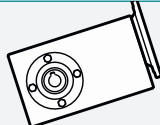
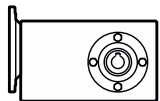
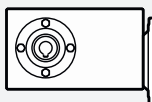
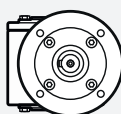
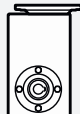
Vedi Tabella 2 per i carichi radiali e assiali applicabili al riduttore.

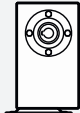
Agip Telium VSF 320	Shell Omala S4 WE 320	V8 On request ASK	
B3 Standard 1.25 LT		B8 On request 1.60 LT	
B6 On request 1.70 LT		V5 On request 2.45 LT	
B7 On request 0.95 LT		V6 On request 1.50 LT	

Radial and axial loads

Carichi radiali e assiali

Output shaft

Albero di uscita

n_2 [min ⁻¹]	F_A [N]	F_R [N]
250	600	3000
150	700	3500
100	780	3900
75	890	4450
50	1140	5700
25	1330	6650
15	1660	8300

$$F_{eq} = F_R \cdot \frac{69}{X + 39}$$

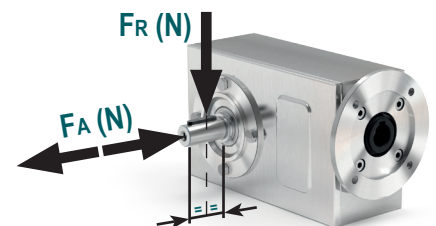
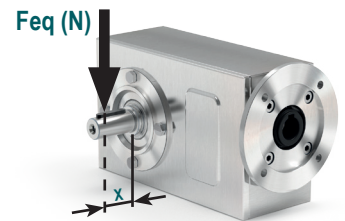

Tab. 1

Tab. 2

410
Nm

X62L

PX62L... Basic gearbox
Riduttore base

Gearbox weight 19.5 kg
Peso riduttore

M. flanges	Kit code	øF	A
80-90 B5	KI854042	200	255.5
100-112 B14	KI854041	160	264.5

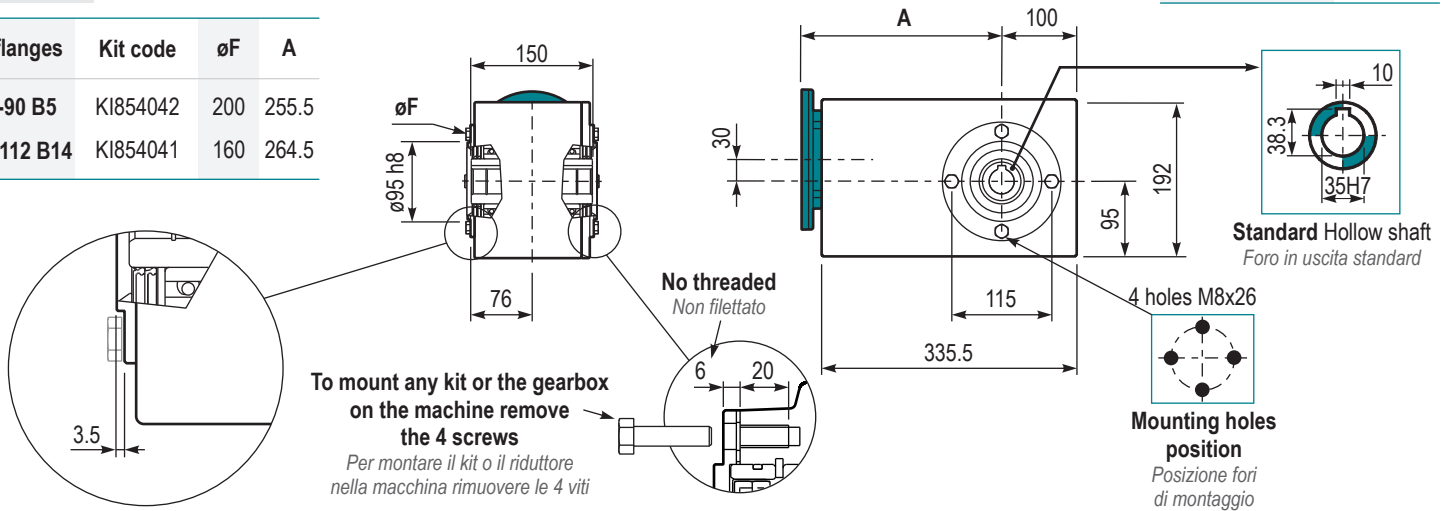

PX62L PA.. Feet
Piedini

PX62L PV.. Feet
Piedini

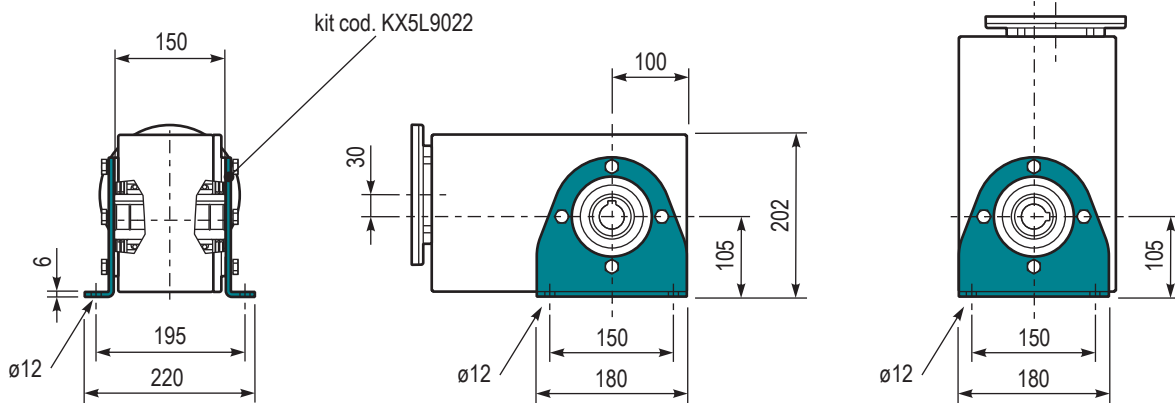

PX62L A.. Single output shaft
Albero semplice in uscita

PX62L BR.. Reaction Arm
Braccio di reazione

cod. X5L0209
Protection cap (on request)
A richiesta coperchio di protezione

