



QUICK SELECTION / Selezione veloce

input speed (n_1) = 1400 min⁻¹

Output Speed n_2 [min ⁻¹]	Ratio i	Motor power P_{1M} [kW]	Output torque M_{2M} [Nm]	Service factor f.s.	Nominal power P_{1R} [kW]	Nominal torque M_{2R} [Nm]	Available B5 motor flanges		Available B14 motor flanges		Dynamic efficiency RD	Tooth Module [mm]	Ratios code
							-A	-B	-O	-P			
							56	63	56	63			
280	5	0.18	5	3.3	0.60	17	B		B-C		82	1.26	09
200	7	0.18	7	2.4	0.44	17	B		B-C		80	1.44	01
140	10	0.18	10	1.8	0.32	17	B		B-C		78	1.44	02
93	15	0.18	13	1.4	0.25	19	B		B-C		73	1.44	03
70	20	0.18	17	1.1	0.20	19	B		B-C		70	1.09	04
47	30	0.12	15	1.4	0.17	21	B		B-C		62	1.44	05
35	40	0.12	19	1.1	0.13	20	B		B-C		57	1.09	06
23	61	0.09	19	1.1	0.10	20	B		B-C		50	0.72	07
17.5	80	0.06	16	1.0	0.06	16	B		B-C		48	0.56	08
14	100	0.06*	16	0.5	0.03	8	B		B-C		40	0.45	10

A) Motor Flanges Available
Flange Motore Disponibili

B) Supplied with Reduction Bushing
Fornito con Bussola di Riduzione

B) Available on Request without reduction bushing
Disponibile a Richiesta senza Bussola di Riduzione

C) Motor Flange Holes Position
Posizione Fori Flangia Motore

* Power higher than the maximum one which can be supported by the gearbox. Select according to the torque M_{2R}
Potenza superiore a quella massima sopportabile dal riduttore. Selezionare in base al momento torcente M_{2R}

EN Unit 030 is supplied with synthetic oil, providing "long life" lubrication. For mounting position V5-V6 please contact us.
See table 1 for lubrication and recommended quantity. In table 2 please see possible radial loads and axial loads on the gearbox.

I Il riduttore tipo 030 viene fornito lubrificato a vita con olio sintetico. Per posizioni V5-V6 contattare il ns. servizio tecnico.
Vedi tab.1 per oli e quantità consigliati. In tab.2 sono presenti i carichi radiali e assiali applicabili al riduttore.

D Für die Lebensdauerschmierung ist das Getriebe der Größe 030 mit synthetischem Öl befüllt. Bei Einbaulage V5 oder V6 bitten wir um Rücksprache. In Tabelle 1 ist die Schmiermenge und das empfohlene Schmiermittel angegeben. In Tabelle 2 sind die zulässigen Radial- und Axialbelastungen des Getriebes aufgeführt.

F Le réducteur de type 030 est fourni lubrifié à vie avec de l'huile synthétique. Concernant les positions V5.V6, contactez notre service d'assistance technique. Voir tableau 1 concernant les huiles et les quantités conseillées. Les charges radiales et axiales applicables au réducteur sont précisées dans le tableau 2.

E El reductor tamaño 030 se suministra, lubricado de por vida con aceite sintético. Para las posiciones V5 y V6 contactar con nuestro servicio técnico. Ver tabla 1, para cantidades y aceites recomendados. En la tabla 2, se encuentran las cargas radiales y axiales admitidas por el reductor.

LUBRICATION 030 Oil Quantity 0.03 Lt.

AGIP Telium VSF 320

SHELL Omala S4 WE 320

For all details on lubrication and plugs check our website **tab. 1**
Per maggiori dettagli su lubrificazione e tappi olio vedi il nostro sito web

RADIAL AND AXIAL LOADS

Output shaft

Albero di uscita

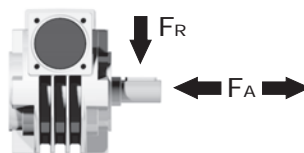

n_2 [min ⁻¹]	FA [N]	FR [N]
200	120	600
150	140	700
100	160	800
75	180	900
50	200	1000
25	250	1250
15	280	1400

Input shaft

albero in entrata

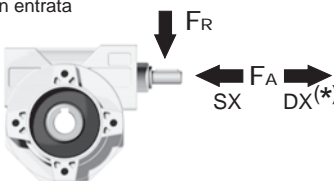

n_1 [min ⁻¹]	FA [N]	FR [N]
1400	20	100

*Strong axial loads in the DX direction are not allowed.
Non sono consentiti forti carichi assiali con direzione DX

tab. 2

P030FB... Basic wormbox
Riduttore base

Gearbox weight
peso riduttore **1.05 kg**

M. flanges	Kit code	øF	A
56B5	K030.4.041	120	61.5
63B5	K030.4.042	140	62.5
56B14	K030.4.046	80	61.5
63B14	K030.4.045	90	62.5

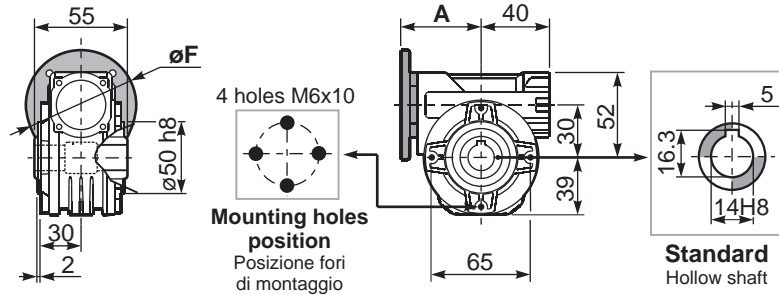

P030PA... Feet
Piedini

P030PB... Feet
Piedini

P030PV... Feet
Piedini

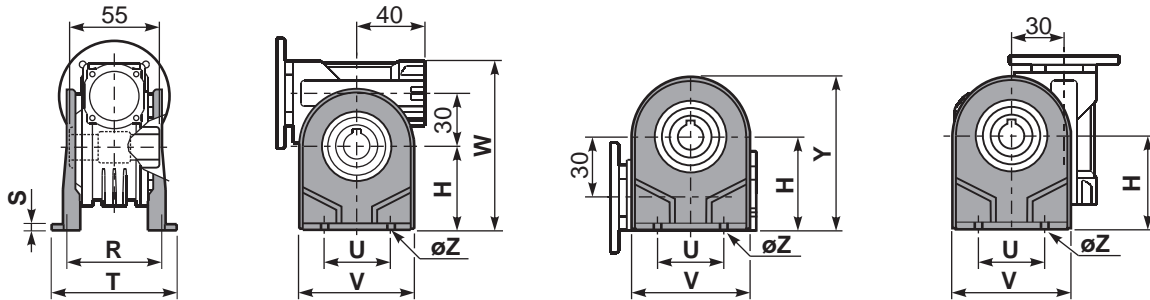

	H	R	S	T	U	V	Y	W	øZ	kit code
type B	55	66	3	87	50	78	94	107	ø6.5	K030.9.022
type S	52	66	3	87	52	90	91	104	ø6.5	KS030.9.023

P030FC... Output flange
Flangia uscita

P030BR... Reaction arm
Braccio di reazione

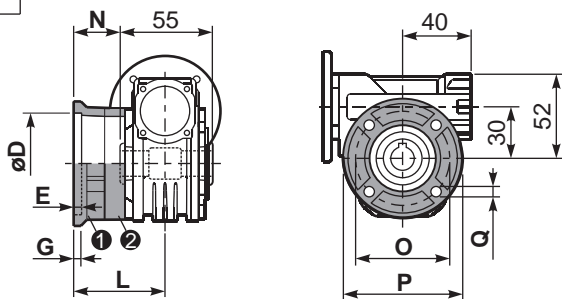

type B	øD	E	G	L	N	O	P	Q	kit code
FC	50 ^{+0.15} / _{+0.05}	6	6	50.5	23	68	80	7	1 K030.9.010 2 -
FL	60 ^{+0.15} / _{+0.05}	6	6	55.5	28	87	110	8.5	1 K045.9.010 2 -

type S	øD	E	G	L	N	O	P	Q	kit code
F1	40 ^{+0.15} / _{+0.10}	3.5	5.5	49	21.5	56	80	6.5	1 KS030.9.012 2 -

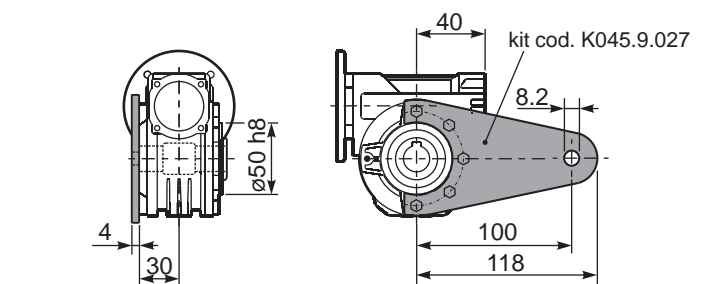

P030.....S... Single Shaft
Albero lento semplice

P030.....D... Double Shaft
Albero lento bisp.

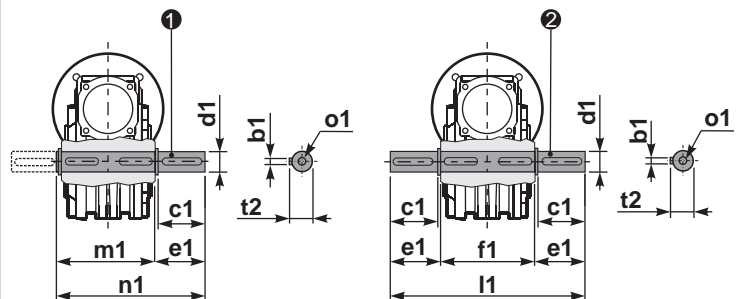

1 kit cod. K030.5.028 type B 2 kit cod. K030.5.029 type B

R030FB... Input shaft
Albero in entrata

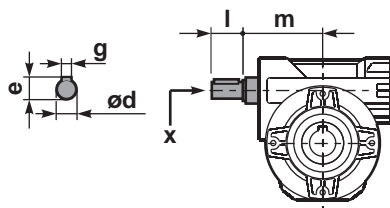

	ød	e	g	l	m	x	kit code
type B	9 h6	10.2	3	20	58	-	K030.5.006 PAM63
type S	-	-	-	-	-	-	-

	b1	c1	d1	e1	f1	l1	m1	n1	t2	o1
type B	5	25	14 ^{-0.005} / _{-0.020}	35.5	55	126	59	94.5	16	M5x14
type S	-	-	-	-	-	-	-	-	-	-