

QUICK SELECTION / Selezione veloce

input speed (n_1) = 1400 min⁻¹

Output Speed n_2 [min ⁻¹]	Ratio i	Motor power P_{1M} [kW]	Output torque M_{2M} [Nm]	Service factor f.s.	Nominal power P_{1R} [kW]	Nominal torque M_{2R} [Nm]	Available B5 motor flanges			Available B14 motor flanges		Dynamic efficiency RD	Tooth Module [mm]	Ratios code
							-A	-B	-C	-P	-Q			
							56	63	71	63	71			
47	30.1	0.25	38	1.4	0.36	55				C		74	2.2	01
33	43.0	0.25	53	1.0	0.26	55				C		72	2.2	02
23	60.2	0.25	62	0.9	0.22	55				C		60	2.4	03
15.5	90.3	0.12	42	1.3	0.16	55				C		57	1.6	04
11.6	120	0.12	52	1.1	0.13	55				C		53	2.5	05
8.8	159	0.12	64	0.9	0.10	55				C		49	1.8	06
7.1	198	0.12*	55	<0.8	0.09	55				C		47	1.5	07
5.4	258	0.12*	55	<0.8	0.07	55				C		45	1.2	08
4.7	301	0.12*	39	<0.8	0.05	39				C		40	1.0	09
3.2	439	0.12*	39	<0.8	0.04	39				C		36	0.72	10

A) Motor Flanges Available
Flange Motore Disponibili

B) Supplied with Reduction Bushing
Fornito con Bussola di Riduzione

Available on Request without reduction bushing
Disponibile a Richiesta senza Bussola di Riduzione

C) Motor Flange Holes Position
Posizione Fori Flangia Motore

* Power higher than the maximum one which can be supported by the gearbox. Select according to the torque M_{2R}
Potenza superiore a quella massima sopportabile dal riduttore. Selezionare in base al momento torcente M_{2R}

EN Unit **P45** is supplied with synthetic oil, providing "long life" lubrication. For mounting position V5-V6 please contact us. See table 1 for lubrication and recommended quantity. In table 2 please see possible radial loads and axial loads on the gearbox.

I Il riduttore tipo **P45** viene fornito lubrificato a vita con olio sintetico. Per posizioni V5-V6 contattare il ns. servizio tecnico. Vedi tab.1 per oli e quantità consigliati. In tab.2 sono presenti i carichi radiali e assiali applicabili al riduttore.

D Für die Lebensdauerschmierung ist das Getriebe der Größe **P45** mit synthetischem Öl befüllt. Bei Einbaulage V5 oder V6 bitten wir um Rücksprache. In Tabelle 1 ist die Schmiermenge und das empfohlene Schmiermittel angegeben. In Tabelle 2 sind die zulässigen Radial- und Axialbelastungen des Getriebes aufgeführt.

F Le réducteur de type **P45** est fourni lubrifié à vie avec de l'huile synthétique. Concernant les positions V5.V6, contactez notre service d'assistance technique. Voir tableau 1 concernant les huiles et les quantités conseillées. Les charges radiales et axiales applicables au réducteur sont précisées dans le tableau 2.

E El reductor tamaño **P45** se suministra, lubricado de por vida con aceite sintético. Para las posiciones V5 y V6 contactar con nuestro servicio técnico. Ver tabla 1, para cantidades y aceites recomendados. En la tabla 2, se encuentran las cargas radiales y axiales admitidas por el reductor.

LUBRICATION P45 Oil

Common lubrication 0.17 l (A + B).



AGIP Telium VSF 320

SHELL Omala S4 WE 320

For all details on lubrication and plugs check our website **tab. 1**
Per maggiori dettagli su lubrificazione e tappi olio vedi il nostro sito web

RADIAL AND AXIAL LOADS

Output shaft
Albero di uscita

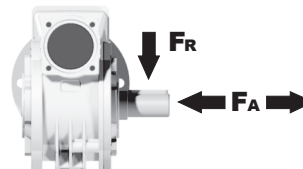

n_2 [min ⁻¹]	FA [N]	FR [N]
75	240	1200
50	260	1400
25	300	1800
15-6	400	2000

Input shaft
albero in entrata

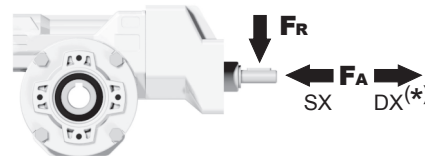

n_1 [min ⁻¹]	FA [N]	FR [N]
1400	44	220

*Strong axial loads in the DX direction are not allowed.
Non sono consentiti forti carichi assiali con direzione DX

tab. 2

PP45FB... Basic wormbox
Riduttore base

Gearbox weight
peso riduttore **3.20 kg**

M. flanges	Kit code	øF	A
56B5	K050.4.046	120	137.5
63B5	K050.4.041	138	139.5
71B5	K050.4.042	160	137
63B14	K050.4.047	90	139.5
71B14	K050.4.045	105	137

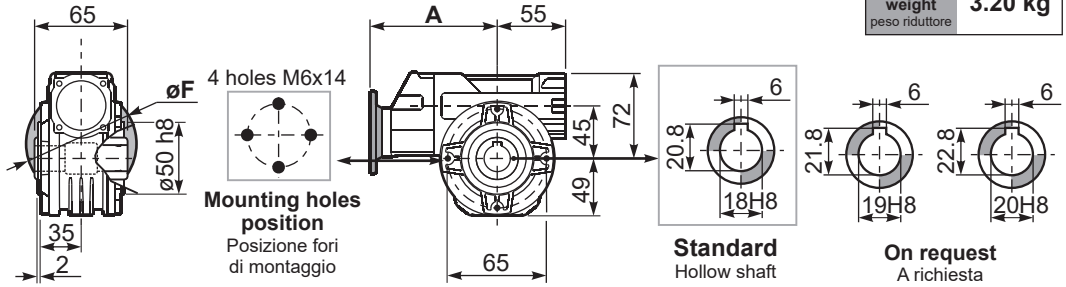

Standard
Hollow shaft

On request
A richiesta

PP45PA... Feet
Piedini

PP45PB... Feet
Piedini

PP45PV... Feet
Piedini

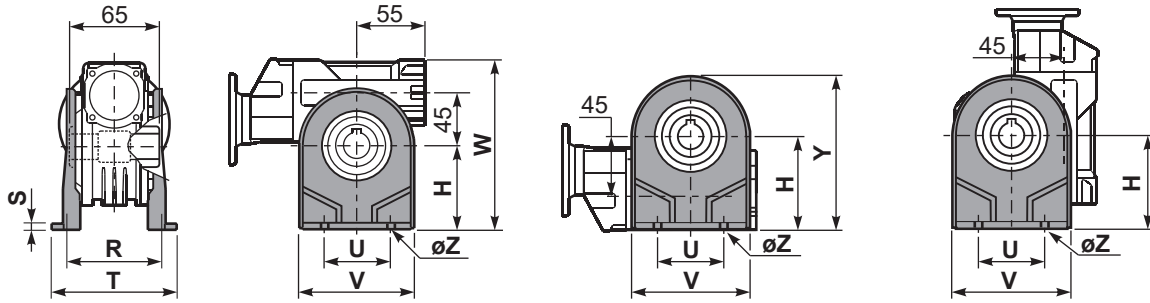

	H	R	S	T	U	V	Y	W	øZ	kit code
type B	72	81	3	100	52	98	121	144	ø10.5	K045.9.022
type S	71	84	8	100	70	90	120	143	ø8	KS045.9.023

PP45FC... Output flange
Flangia uscita

PP45BR... Reaction arm
Braccio di reazione

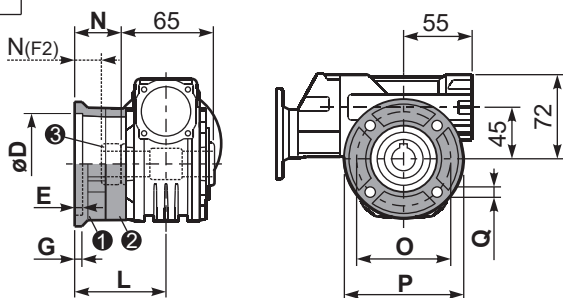

type B	øD	E	G	L	N	O	P	Q	kit code
FC	60 ^{+0.15} / _{-0.05}	9	9	60.5	28	87	110	8.5	① K045.9.010 ② -
FL	60 ^{+0.15} / _{-0.05}	9	9	90.5	58	87	110	8.5	① K045.9.010 ② K045.0.200

type S	øD	E	G	L	N	O	P	Q	kit code
F1	95 ^{+0.20} / _{-0.15}	4	11	73.5	41	115	140	9	① KS045.9.013 ② -
F2	60 ^{+0.15} / _{-0.05}	9	9	60.5	19	87	110	8.5	① KS045.9.010 ② S045.0.204
F3	80 ^{+0.03} / _{-0.00}	3	8	51.5	19	100	120	9	① KS045.9.014 ② -

PP45....S... Single Shaft
Albero lento semplice

PP45....D... Double Shaft
Albero lento bisp.

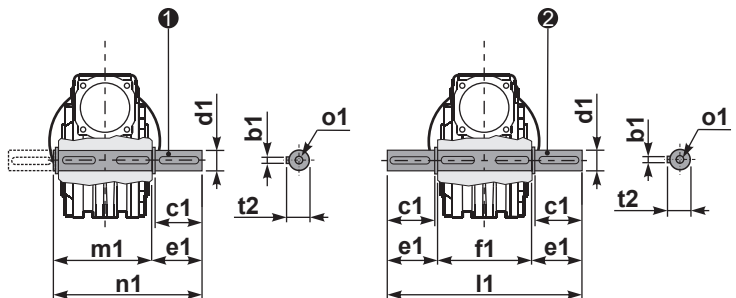

① kit cod. K045.5.028 type B
kit cod. KS045.5.030 type S

② kit cod. K045.5.029 type B

RP45FB... Input shaft
Albero in entrata

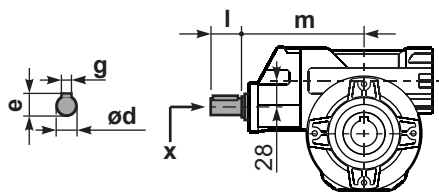

	ød	e	g	l	m	x
type B	14 h6	16	5	25	131	M5x13
type S	-	-	-	-	-	-

	b1	c1	d1	e1	f1	l1	m1	n1	t2	o1
type B	6	32	18 ^{-0.005} / _{-0.020}	43	65	151	70	113	20.5	M6x18
type S	6	40	19 ^{-0.005} / _{-0.020}	58.8	-	-	70	128.5	21.5	M8x20